**NX20-XL**

Needle roller/axial ball bearing

Schaeffler ID:
0507785950000Needle roller/axial ball bearings NX,
single direction axial component, for oil
lubrication

X-life

Technical information

2)

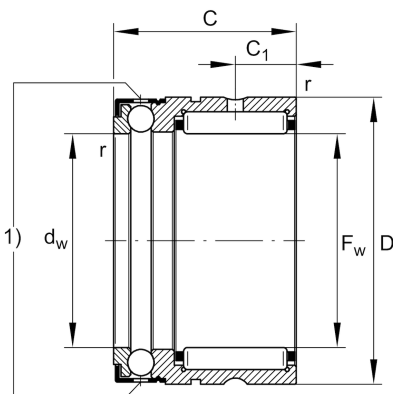
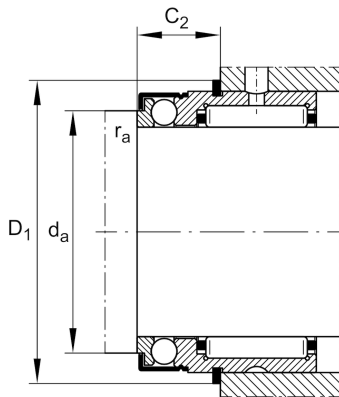
**Main Dimensions & Performance Data**

F_w	20 mm	Bore diameter
D	30 mm	Outside diameter
C	28 mm	Height
C_r	14,600 N	Basic dynamic load rating, radial
C_{0r}	17,500 N	Basic static load rating, radial
C_a	7,000 N	Basic dynamic load rating, axial
C_{0a}	14,700 N	Basic static load rating, axial
C_{ur}	3,300 N	Fatigue load limit, radial
C_{ua}	670 N	Fatigue load limit, axial
n_G	6,500 1/min	Limiting speed
	66.75 g	Weight

Dimensions

	IR17X20X16-XL	Suitable inner rings IR
	WR30, SW30	Snap ring
C_1	8 mm	Distance to lubrication hole
C_2	8 mm	Distance to lubrication hole
d_w	20 mm	Bore diameter of shaft washer
r_{min}	0.3 mm	Minimum chamfer dimension

Mounting dimensions

d_a	25 mm	Mounting dimension shaft shoulder
$r_{a max}$	0.3 mm	Maximum recess radius
D_1	33.6 mm	Connection diameter snap ring
C_2	12.2 mm	Connection width with snap ring

Temperature range

T_{min}	-30 °C	Operating temperature min.
T_{max}	120 °C	Operating temperature max.